

Quad Gutter

A traditional gutter providing value for money. Suitable for the collection of rainwater from one point. Our Quad gutter can be ordered slotted or unslotted with long lengths available (up to 12M). Mack Bros has been manufacturing roofing, cladding and gutters for over 60 years. Our experience in roll forming and knowledge of materials makes us a market leader. Please feel free to contact us on those specialised projects. We can manufacture gutters in any colour across a range of materials including copper, stainless steel and aluminium. We supply a full range of accessories including cast angles (pictured below), custom rainwater heads and downpipes.

Why use our Cast Angles?

1 Manufactured to a superior quality

2 Guide lines and notations to make cutting easy when extending for a QG 150, 175 or 200 gutter.

3 Pilot holes for pop rivets when extending for QG 150, 175 or 200 gutters.

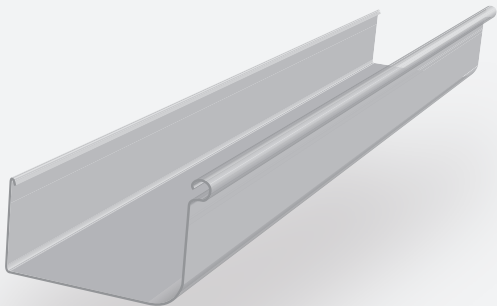
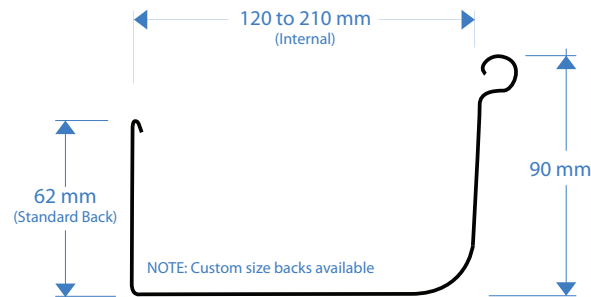

Gutter Type	Internal Gutter Size	Cross Sectional Area (mm ²) Standard Back	Cross Sectional Area (mm ²) 95mm High Back
QG 115	120mm	7,053	N/A
QG 125	135mm	7,971	11,521
QG 150	165mm	9,658	13,886
QG 175	185mm	10,990	15,753
QG 200	210mm	12,323	17,621

QUALITY

since 1946



MACK BROS.

Quad Gutter Accessories

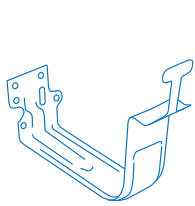

External Bracket
(QG125)

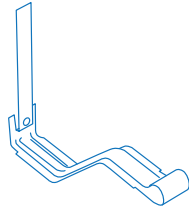

Stiffener Bracket
(QG115, QG125 & QG150)

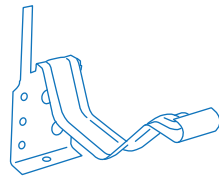

Internal Bracket
(QG115 & QG125)

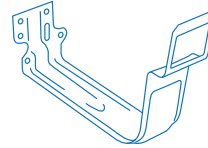

External Bracket
(QG115 & QG150)

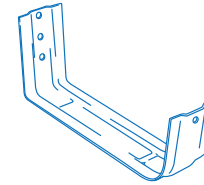

External Bracket
(QG175 & QG200)

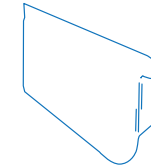

Stop End - Left
Stop Ends sold as a pair

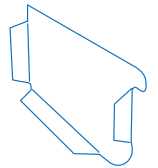

Stop End - Right
Stop Ends sold as a pair

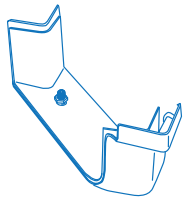

External 90° Cast Angle
(QG115)

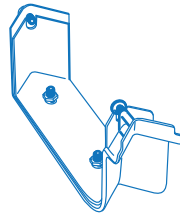

Internal 90° Cast Angle
(QG115)

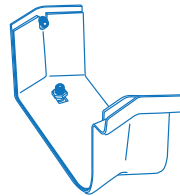

Internal 45° Cast Angle
(QG115)

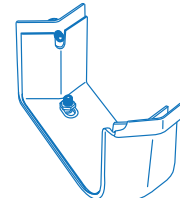

External 45° Cast Angle
(QG115)

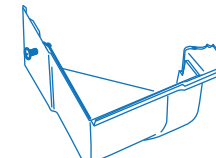

Cast Return End - Left
(QG115)

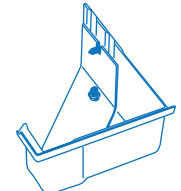

Cast Return End - Right
(QG115)

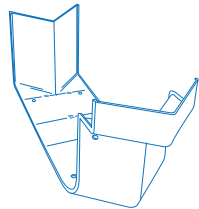

External Cast Angle
(GQ125)

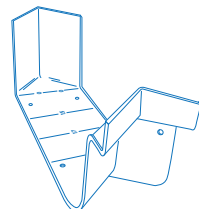

External Cast Angle
(QG125)

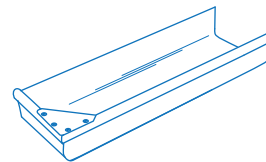

Return Stop End - Left
(All QG)

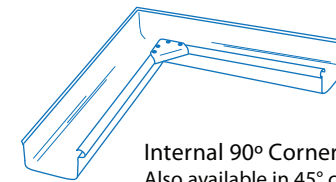

Internal 90° Corner
Also available in 45° corners
(All QG)

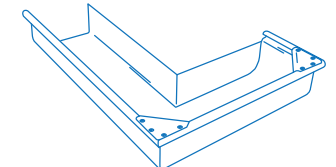

90° Full Return - Right
(All QG)

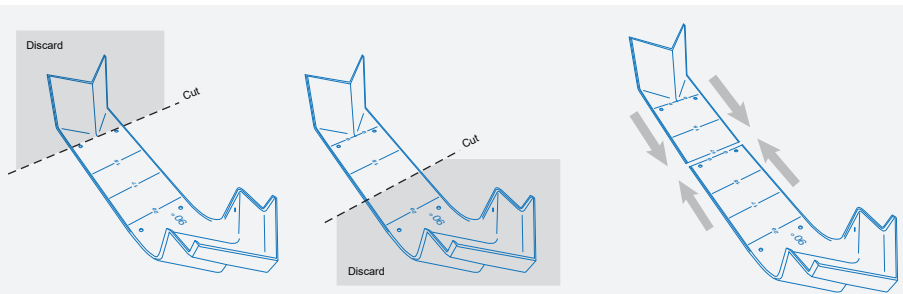

Extend Cast Angles to fit QG150, QG175 and QG200 (Illustration for QG175)

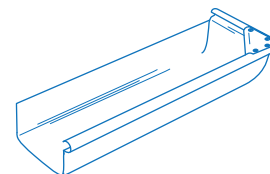

Return Stop End - Right
(All QG)

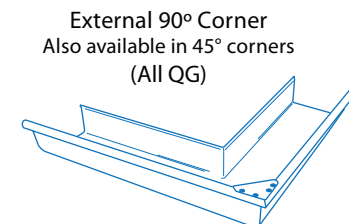

External 90° Corner
Also available in 45° corners
(All QG)

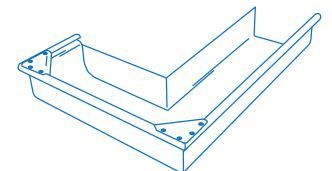

90° Full Return - Left
(All QG)