

# Half Round Gutter

An architecturally pleasing European look that allows water to disperse quickly. Mack Bros has been manufacturing roofing, cladding and gutters for over 60 years. Our experience in roll forming and knowledge of materials makes us a market leader. Please feel free to contact us on those specialised projects. We can manufacture gutters in any colour across a range of materials including copper, stainless steel and aluminium. We supply a full range of accessories including heavy duty type A4 brackets (pictured below), custom rainwater heads and downpipes.

## Why use our Heavy Gauge A4 Brackets?

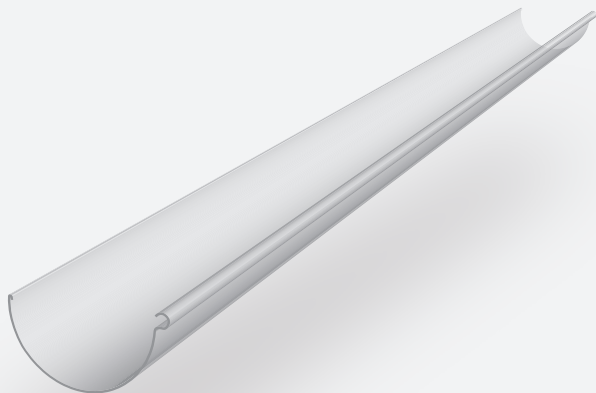
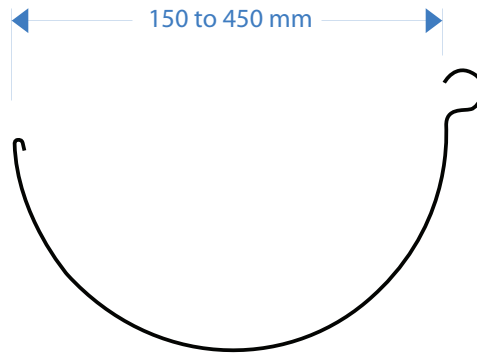
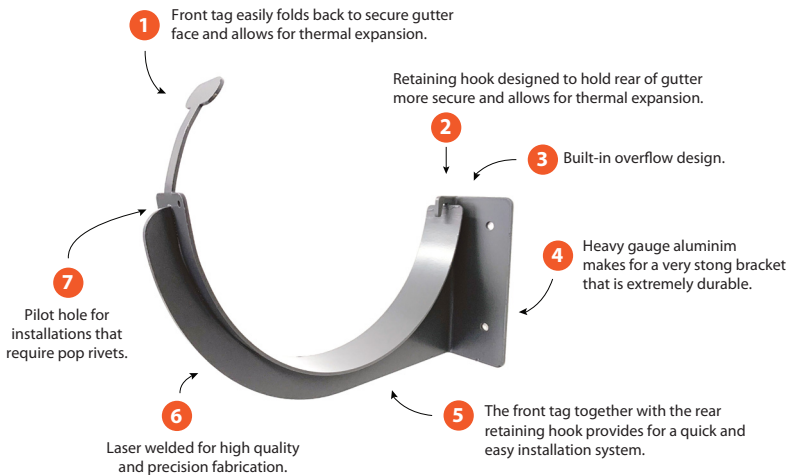

Gutter Size (mm)	Cross Sectional Area (mm <sup>2</sup> )
150	10,200
200	14,500
225	20,200
250	25,000
300	36,000
350	48,600
400	63,600
450	79,500

QUALITY

since 1946

MACK  
BROS.

# Half Round Gutter Accessories

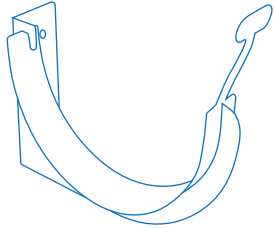

External Bracket A4  
(All Half Round Gutter sizes)

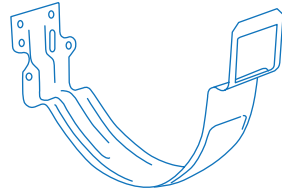

150mm External Bracket

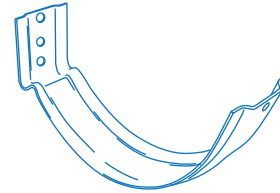

200mm External Bracket

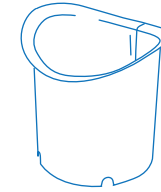

Pops 75mm, 90mm, 100mm,  
125mm, 150mm, 200mm  
& 225mm Zinalume

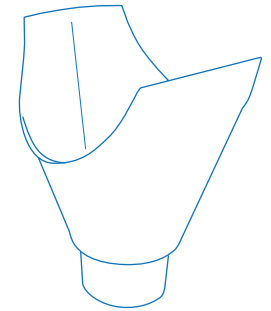

Rainhead Sump

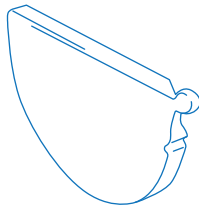

Stop End - Left

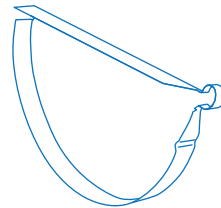

Stop End - Right

(All Half Round Gutter sizes)  
Stop Ends sold as pair

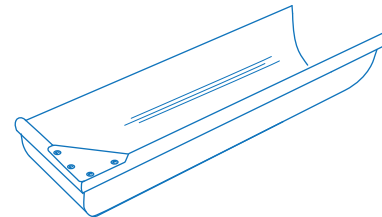

Return Stop End - Left  
(All Half Round Gutter sizes)

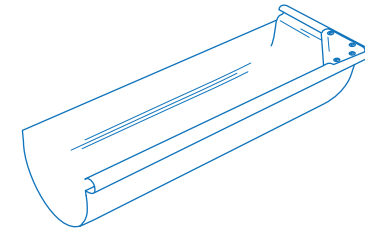

Return Stop End - Right  
(All Half Round Gutter sizes)

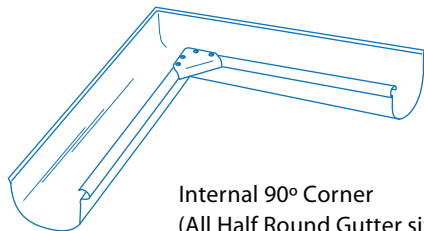

Internal 90° Corner  
(All Half Round Gutter sizes)  
Also available in 45° corners

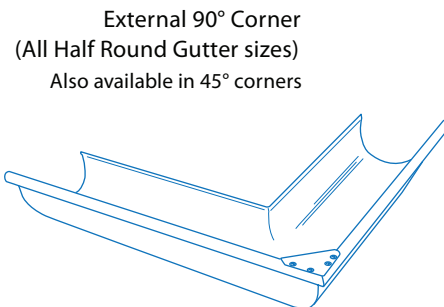

External 90° Corner  
(All Half Round Gutter sizes)  
Also available in 45° corners



90° Full Return - Left  
(All Half Round Gutter sizes)

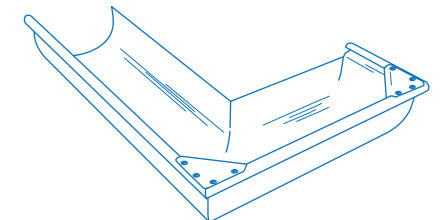

90° Full Return - Right  
(All Half Round Gutter sizes)

# Half Round Gutter Accessories - Cast

Half Round 150mm, 200mm & 250mm - Cast

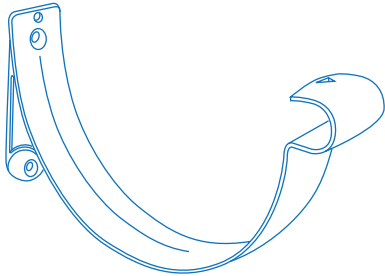

External Bracket  
(150mm only)

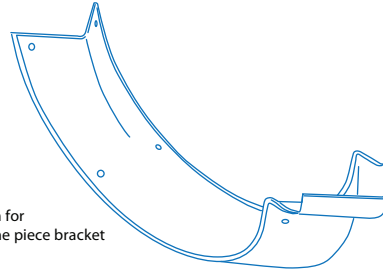

Illustration for  
150mm one piece bracket

External 90°  
(also available as 45° angle)

150mm 90° - one piece bracket  
150mm 45° - two piece bracket  
200mm 90° only - two piece bracket  
250mm 90° only - two piece bracket

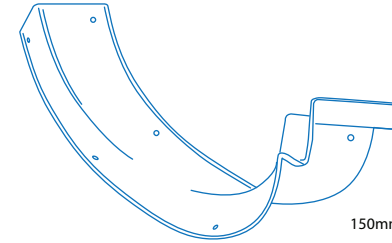

Illustration for  
150mm one piece bracket

Internal 90°  
(also available as 45° angle)

150mm 90° - one piece bracket  
150mm 45° - two piece bracket  
200mm 90° only - two piece bracket  
250mm 90° only - two piece bracket

	150mm	200mm	225mm	250mm	300mm	350mm	400mm	450mm
External Bracket - Pressed	HR15EB	HR20EB	-	-	-	-	-	-
External Bracket - Cast	HR15ED	-	-	-	-	-	-	-
External Bracket - A4	HR15EA	HR20EA	HR22EA	HR25EA	HR30EA	HR35EA	HR40EA	HR45EA
Pair Stop Ends (Left & Right)	HR15SE	HR20SE	HR22SE	HR25SE	HR30SE	HR35SE	HR40SE	HR45SE
External 90° Cast Angle	HR15E9	HR20E9	-	HR25E9	-	-	-	-
Internal 90° Cast Angle	HR15I9	HR20I9	-	HR25I9	-	-	-	-
External 45° Cast Angle	HR15E4	-	-	-	-	-	-	-
Internal 45° Cast Angle	HR15I4	-	-	-	-	-	-	-
Return Stop End - Left	HR15RL	HR20RL	HR22RL	HR25RL	HR30RL	HR35RL	HR40RL	HR45RL
Return Stop End - Right	HR15RR	HR20RR	HR22RR	HR25RR	HR30RR	HR35RR	HR40RR	HR45RR
External 90° Corner	HR15AE	HR20AE	HR22AE	HR25AE	HR30AE	HR35AE	HR40AE	HR45AE
Internal 90° Corner	HR15AI	HR20AI	HR22AI	HR25AI	HR30AI	HR35AI	HR40AI	HR45AI
External 45° Corner	HR15E4	HR20E4	HR22E4	HR25E4	HR30E4	HR35E4	HR40E4	HR45E4
Internal 45° Corner	HR15I4	HR20I4	HR22I4	HR25I4	HR30I4	HR35I4	HR40I4	HR45I4
90° Full Return - Left	HR15DL	HR20DL	HR22DL	HR25DL	HR30DL	HR35DL	HR40DL	HR45DL
90° Full Return - Right	HR15DR	HR20DR	HR22DR	HR25DR	HR30DR	HR35DR	HR40DR	HR45DR

# Half Round Custom Brackets

## *Our A4 brackets can easily be customised*

Whether you have an architectural CAD file or a hand written sketch, we can help you customise our A4 brackets to suit your project. Our in-house experts can assist from design to manufacturing your unique bracket.

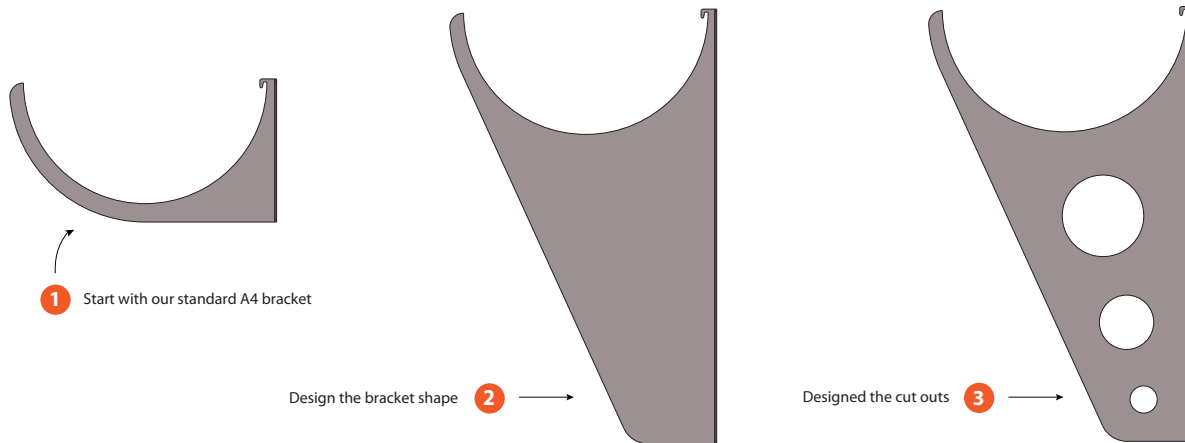

## Custom Brackets



Project  
Mafra Sports Pavilion

Product  
Custom A4 Brackets



QUALITY

since 1946

# MACK BROS.

## Roofing, Cladding & Gutter Manufacturers

630 Heatherton Road, Clayton South VIC 3169 | [www.mackbros.com.au](http://www.mackbros.com.au) | [sales@mackbros.com.au](mailto:sales@mackbros.com.au) | (03) 9571 7911

As part of Mack Bros Roofing Products Pty Ltd policy of continued improvement, the company reserves the right, at any time, at their discretion and without notice to discontinue or change the features, designs, materials, colours and other specifications of their product and to either permanently or temporarily withdraw such products from the market without incurring any liability. This publication is issued as a general guide only and should not be treated as a substitute for detailed technical advice in relation to individual circumstances. Mack Bros disclaim any liability for loss or damage suffered from the use of such data, except liability under the consumer affairs. To the best of our knowledge all information is correct at time of printing. *30 May 2024*